

İhtisasımız:

Ring İplik Makinaları için

İçten ve Dıştan Tutucular

## RING-SPINNING



Special branche:

In-Out Side Grippers for

Ring Spinning Machinery

T-200

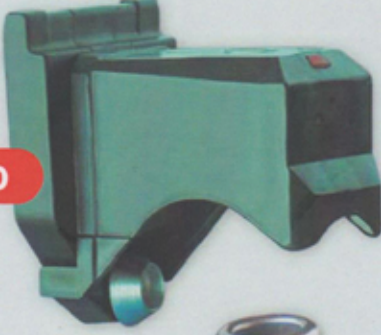

T-001



T-30/33



# RING-SPINNING *(in-outside grippers)*

## Kops Tutucularımız *(Our grippers)*

Deneyiniz *(test the product)*

Special Grippers



T-500

Farkı görünüz *(compare with others)*



T-400

Karar veriniz *(decide)*

rieter\_b28



T-30/33

Alınız *(purchase)*

Zns 013-016



T-200

Kazançlı çıkınız *(make profit)*

Zns

T-101/6

Mükemmelini seçiniz ! *(be perfectionist !)*

Zns 011

Zns 012

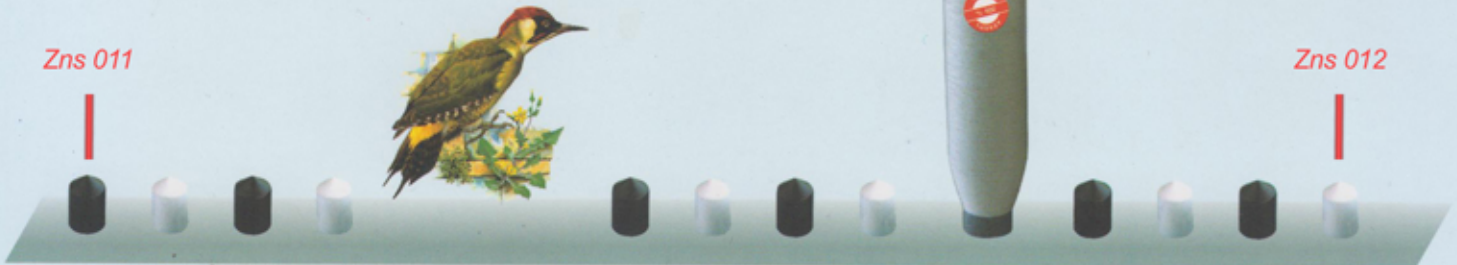

## TÜTÜNCÜLER MÜHENDİSLİK

a succesfull turkish brand in the texile world



## GRIPPERS



## SPECIAL PARTS



**TÜTÜNCÜLER MÜHENDİSLİK İHRACAT SAN. ve TİC. LTD. ŞTİ**

İmes E Blok 504 Sokak No: 5 Yukarı Dudullu-İSTANBUL/TÜRKİYE

Tel : +90 (216) 415 13 94 Faks : +90 (216) 364 99 07

• [www.tutunculer.com.tr](http://www.tutunculer.com.tr) • e-mail : [info@tutunculer.com.tr](mailto:info@tutunculer.com.tr)

## T-200 Kops Tutucusu (T-200 Out Side Grippers)

FOR Zns 013-016

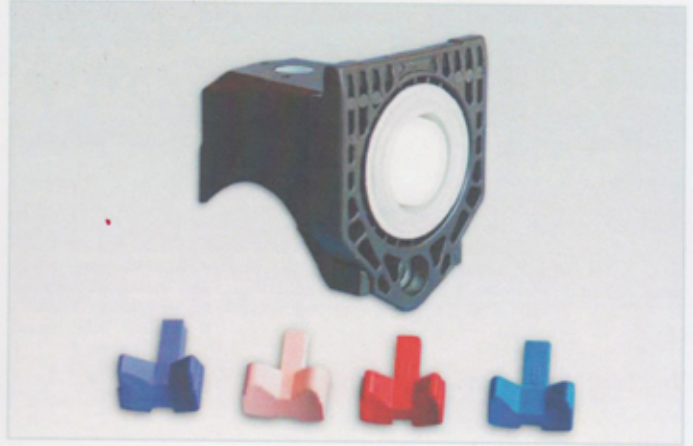

## T-200 Kops Tutucusu (T-200 Out Side Grippers)

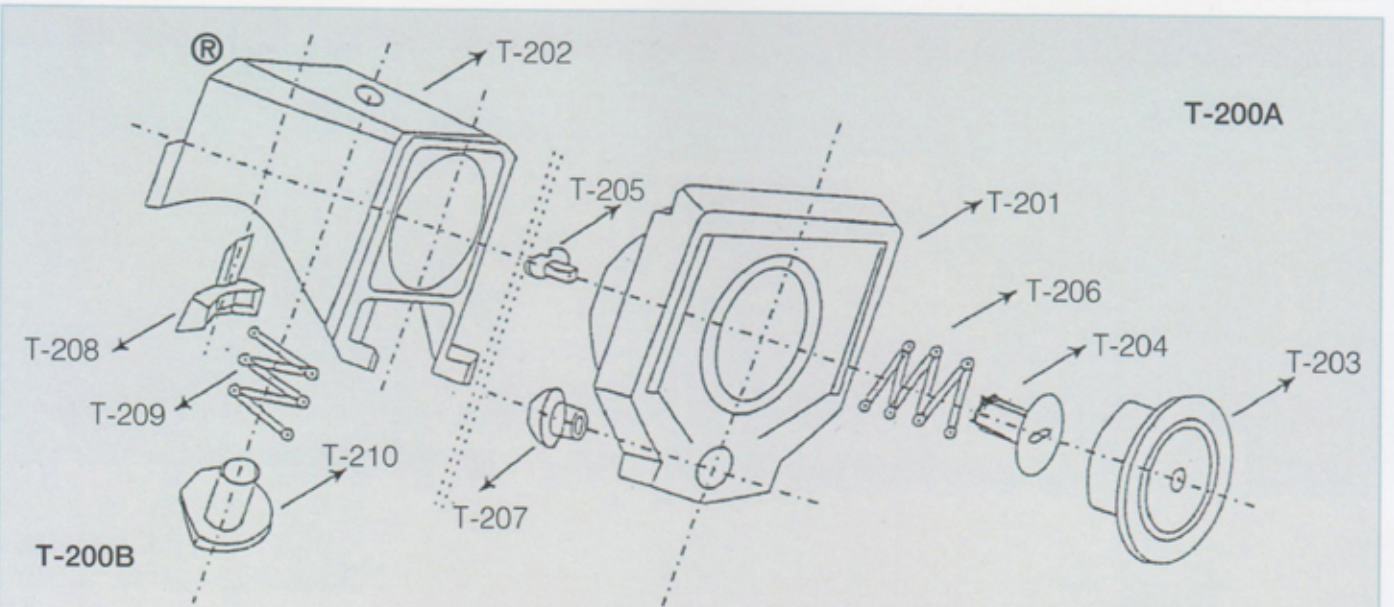

## T-200 (Komple) Kops Tutucu Montaj Parçaları

### T-200 A Arka Gövde Grubu

- T-201 Arka Gövde Plastiği
- T-203 Plastik Conta
- T-204 Dil Gövdesi
- T-205 Dil
- T-206 Yay
- T-207 Metal Yüksük

### T-200 B Örnekbaşı Grubu

- T-202 Ördekbaşı Plastiği
- T-208 Kops Öntutucu Plastiği
- T-209 Yay
- T-210 Dengeleme Plastiği

## T-001-6 Kops Tutucu Balon ( T-001-6 In Side Grippers )

FOR Zns



## T-001-6 Kops Tutucu Balon Ölçüleri

FOR Zns

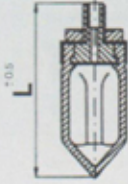

Kod: T-001  
A = 14,2 mm  
L = 50 mm

Kod: T-005  
A = 18 mm  
L = 51 mm

Kod: T-002  
A = 15,2 mm  
L = 50 mm

Kod: T-006  
A = 12,7 mm  
L = 48 mm

## Band Konik Klavuzları ve Ölçüleri

FOR Zns



Band Konik Klavuzları ve Ölçüleri

- 19.00 mm
- 21.00 mm
- 23.50 mm
- 26.00 mm

## Band Kılavuz Bağlantı Pulları

FOR Zns



T-147



T-146



T-177



T-176

## Band Kılavuz Bağlantı Özel Vidaları

FOR Zns



M5X25 Özel Vida



M5X10 Özel Vida

## T-30/33 Kops Tutucusu (T-30/33 Out Side Grippers)

FOR rieter\_b28

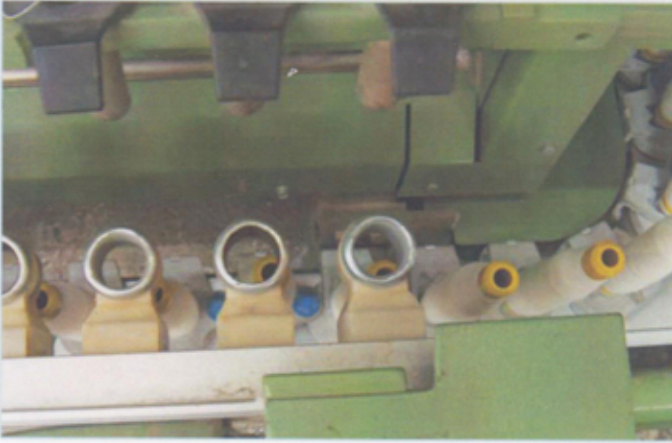

## T-200 Kops Tutucusu (T-200 Out Side Grippers)

### T-30/33

#### T-30/33 ( Komple ) Kops Tutucu Montaj Parçaları

- T-301 Ana Gövde Plastik
- T-302 Metal Yüksük
- T-303 Körük
- T-304 Koruyucu Ayak Plastik
- T-305 Lastik Takoz
- T-306 Yaprak Yaylar

#### T-30/33 KOPS TUTUCUSU (KOMPLE)

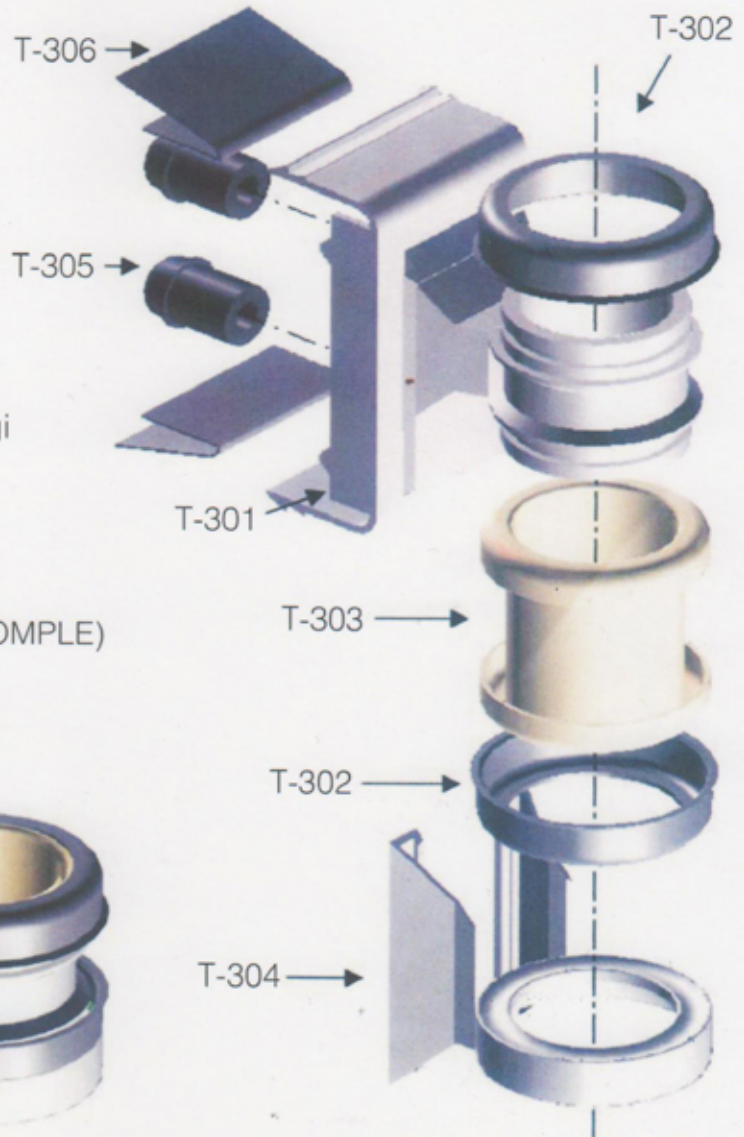

## T-500 TÜRK KOPS TUTUCUSU (Turkish outside grippers)

Zns  
(outside)

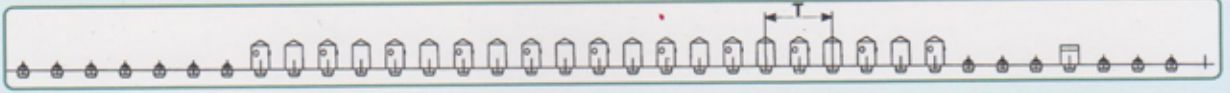
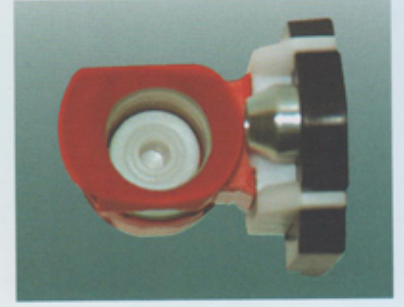
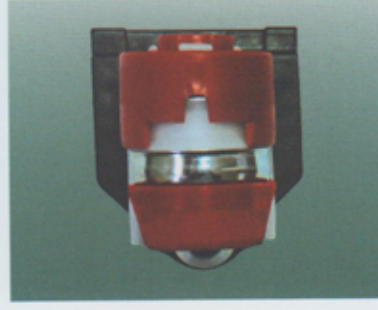
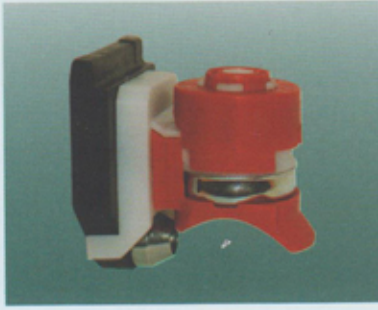

T=Kullanılan iğ eksen aralıkları : 70-75-82,5.... v.s.

## T-400 TÜRK KOPS TUTUCUSU

Zns  
(outside)

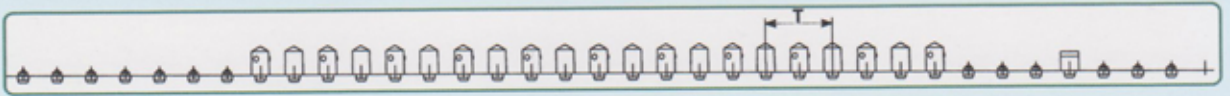
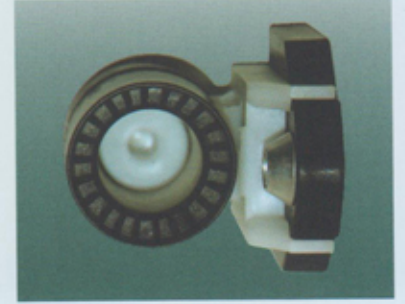
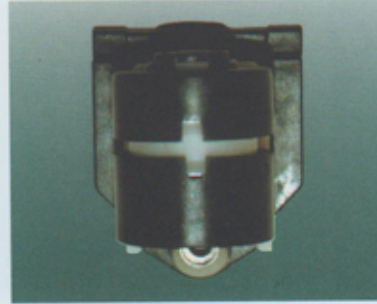
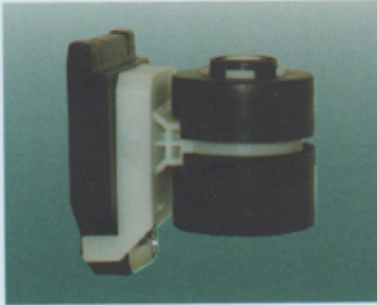

T=Kullanılan iğ eksen aralıkları : 82,5 ve üstü

## T-30/33 KOPS TUTUCUSU (STANDART) (With Special Cap)

rieter  
(outside)

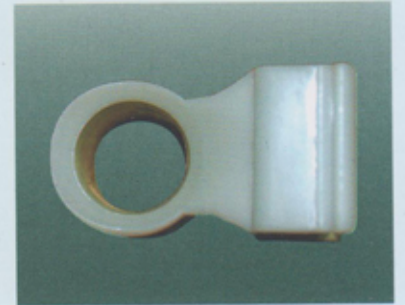
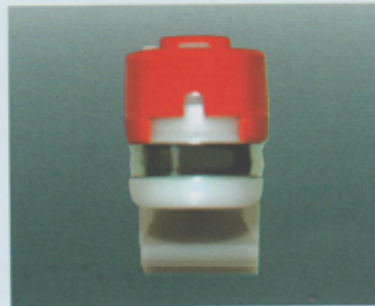

ÖZEL ŞAPKALI